

CONNECTION DIAGRAM

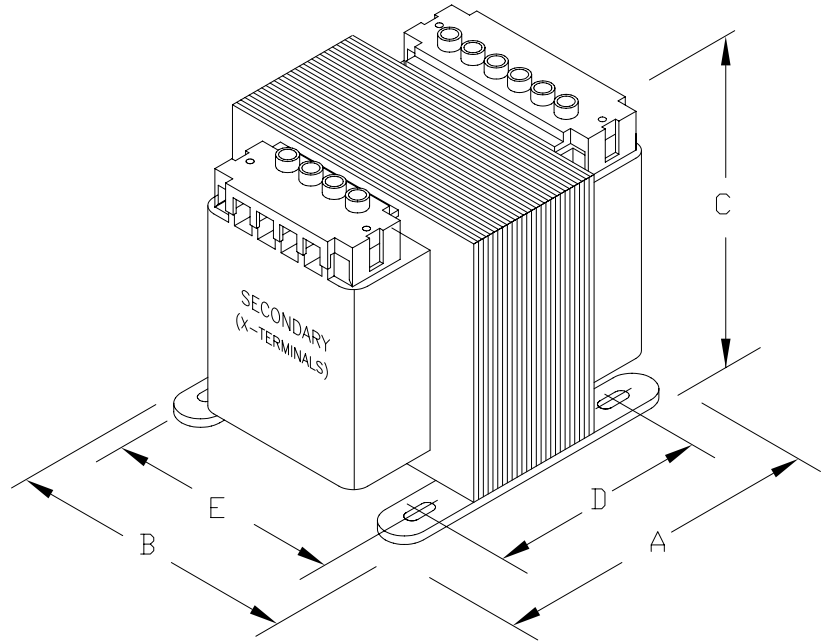

CONNECTION TABLE

INPUT VOLTAGE				OUTPUT VOLTAGE	
H5-H4	H5-H3	H5-H2	H5-H1	X3-X2	X3-X1
220	380	440	550	23	110
230	400	460	575	24	115
240	416	480	600	25	120

PROVIDED WITH SAFE TOUCH TERMINAL COVERS
NO INTEGRAL FUSING CAPABILITY.

DIMENSIONS							APPROX. WT. LBS (KG)
	A	B	C	D	E	MTG. SLOTS	
INCHES (MM)	4.75 (121)	4.50 (114)	4.00 (102)	3.75 (95)	3.75 (95)	0.203X0.844 (5.1X21.4)	



CAT. NO.	B250-2243-GAF		CONST. ENCAPSULATED				UL LISTED
			MODEL GLOBALTRAN				
RATING							SP CERTIFIED
OUTPUT AMPS	10.4/2.2	PRIMARY V	240/416/480/600, 230/400/460/575, 220/380/440/550.		TEMP. CLASS	HZ 50/60	
VA	250	SECONDARY V	25/120, 24/115, 23/110,		130°C	REVISION G	CE IEC 61558